

DETAILED BROCHURE - MR012B08

Technical Parameters

Model No	MR012B08
Type of flow	Radial flow
Borewell Size	6"
Flow Rate	12 m ³ /hr (200 LPM)
Head / Stage	8 Mtrs
Shut off Head	12.5 Mtrs
Power driven by pump / stage	0.36 KW (0.48 HP)
Pump Efficiency	74 %
Rated RPM	2850 @ 50 Hz
No. of Blades	8 (CCW)
Production Method	Investment Casting / Shell Moulding
Compatible Bowl Model No.	MMD012B08

Pump Efficiency @ different Head				
	Head (Mtrs)	Flow Rate		Pump Efficiency (%)
		(m ³ /hr)	LPM	
1	8 (Duty Point)	12	200	74
2	7.20 (-10%)	13.08	218	72
3	10.00 (+25%)	9.2	153	70

Conceptual Design of Impeller

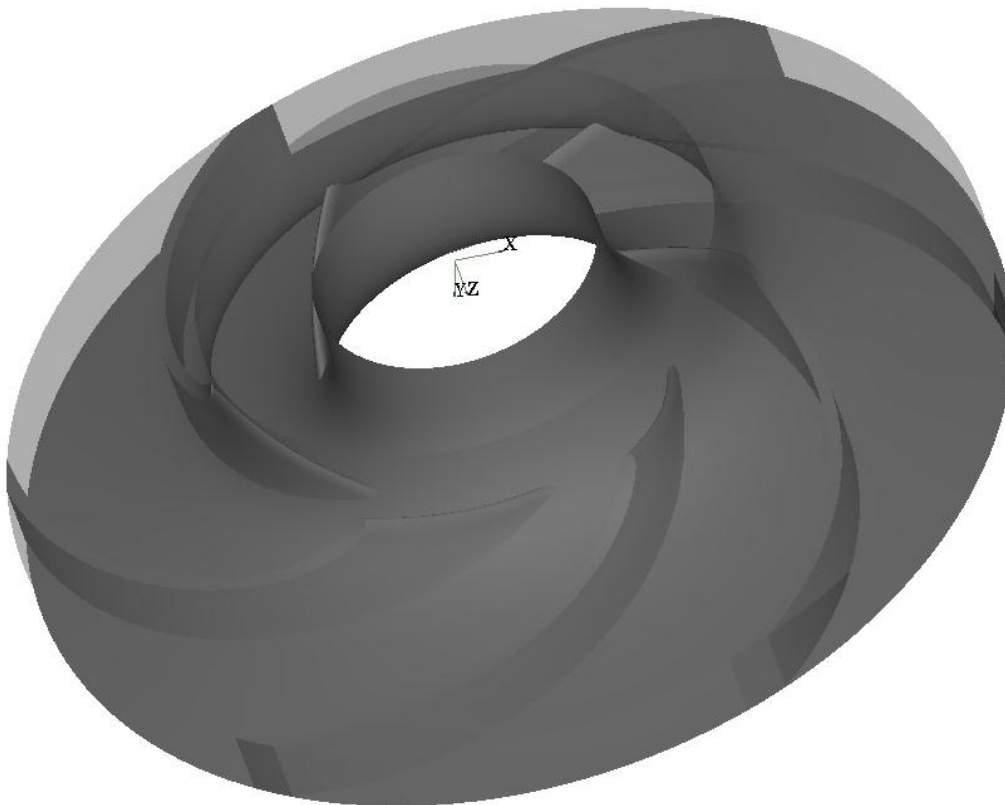

PERFORMANCE GRAPHS

1. Volume Flow vs. Head

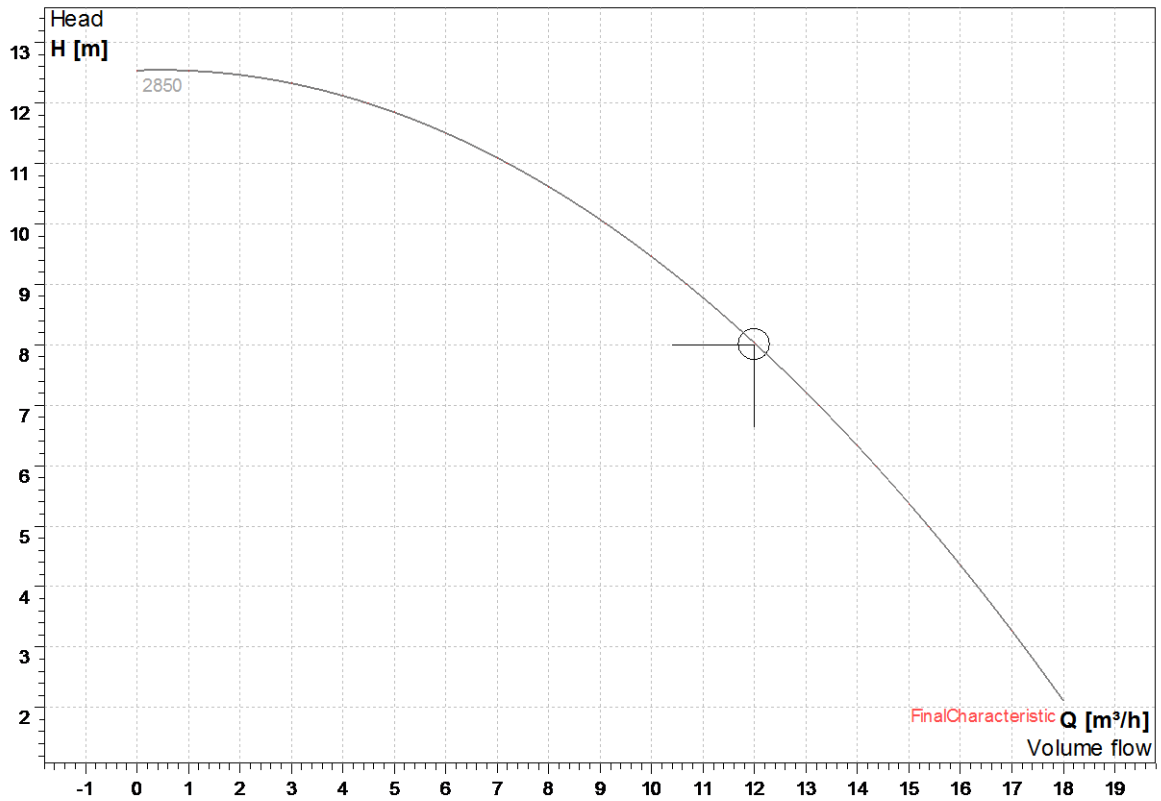

2. Volume Flow vs. Total Efficiency

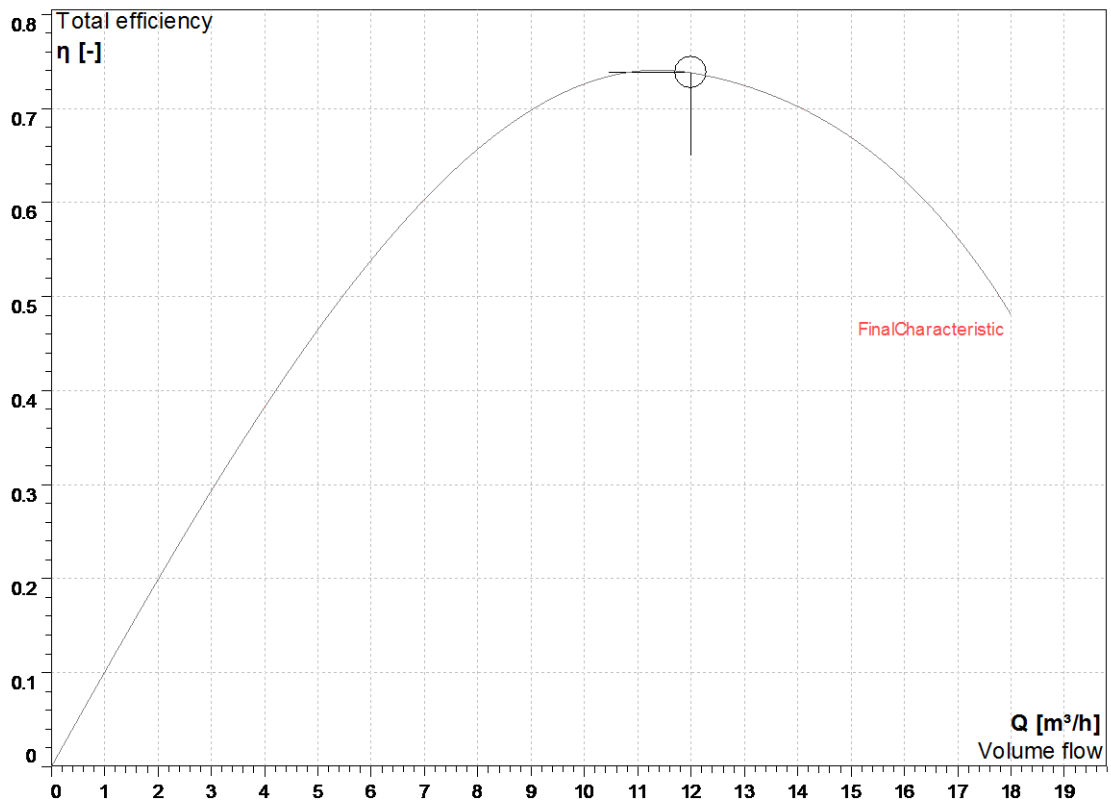

3. Volume Flow vs. Required Driving Power

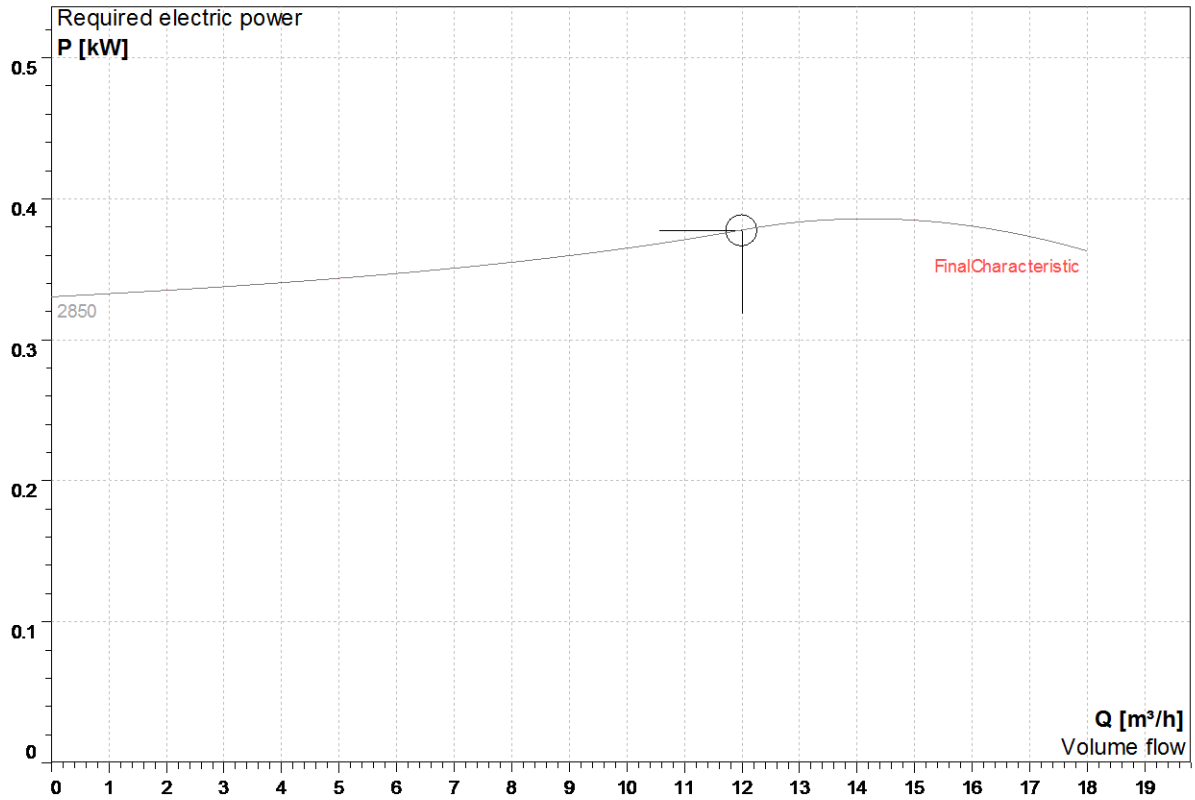

OVERALL DIMENSIONS (Not to Scale)

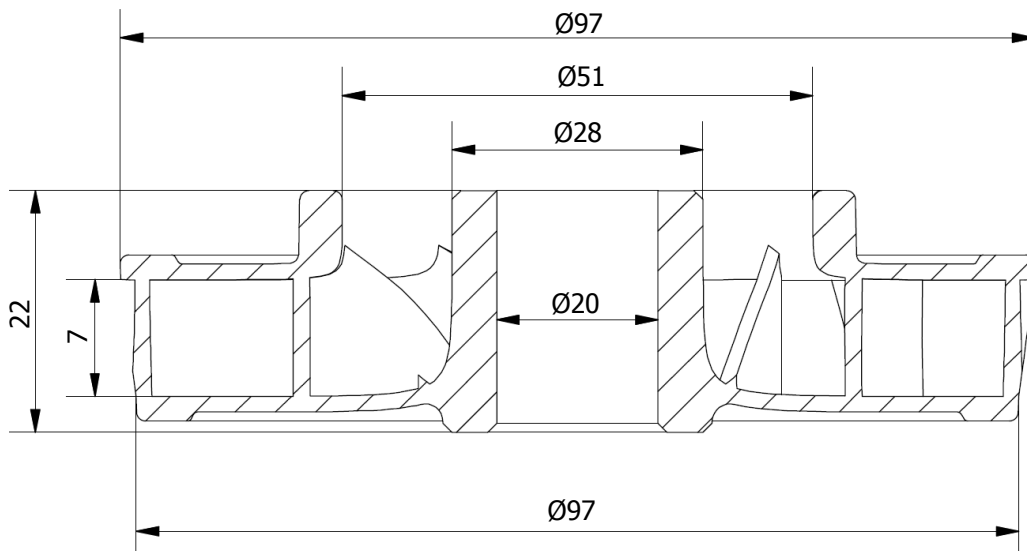

Note: All Dimensions are in mm.

For Your query related to this product please write us on microcare25@microcaregroup.com

Or fill up the Inquiry form given on our website. [Click here to open Inquiry page](#)